

CSST-932DF

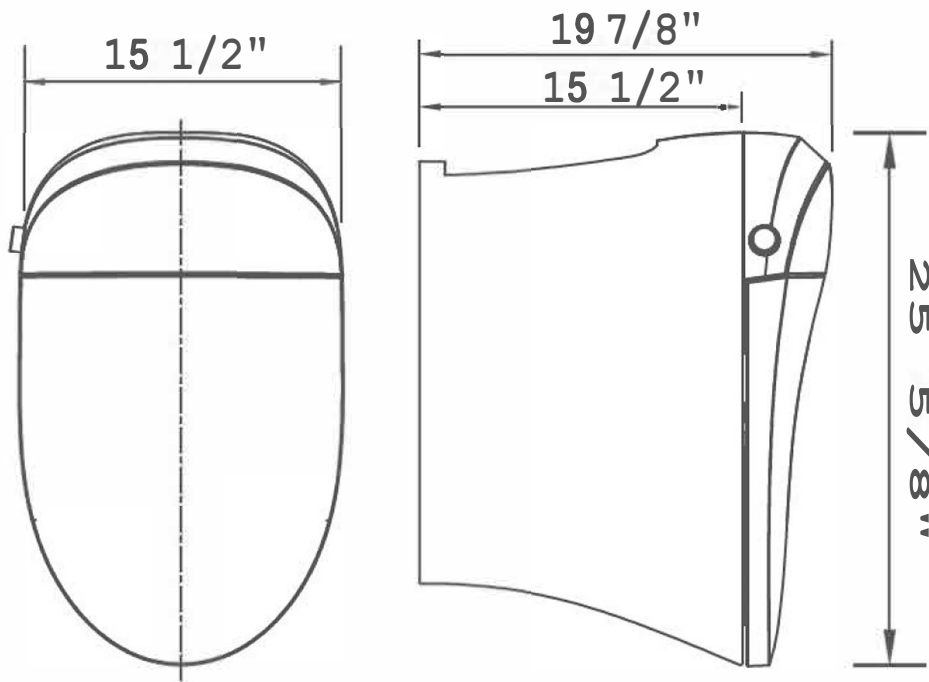



Functional diagram



AIR MIX WATER

Innovative patents

Bottom inhalation air,
give living water more oxygen,
softer and finer water

Technology of dynamic Energy cleaning with soft oxygen,
enjoy SPA with your heart

ENJOY!

AIR





Multispecific cleaning modes

Diversified cleaning function, cleaner flushing, multiple cleaning modes
Meet all the needs of different groups of people, exclusive service, intimate and safer

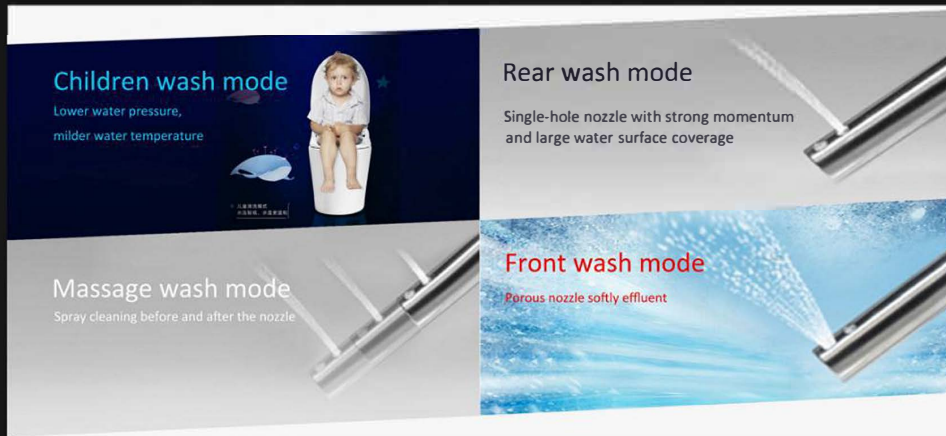

Radar wave/Auto open up seat

Intelligence changes Life

Using intelligent radar sensing technology,
when the human body is close to the toilet 30 cm,
it stays for a few seconds enough for the cover to open automatically.
When you leave, the cover automatically closes
and automatically flushes after two minutes.

CONVENIENT!





Operating Instruction of Dial knob Control

1.introduction of knob symbol and shape

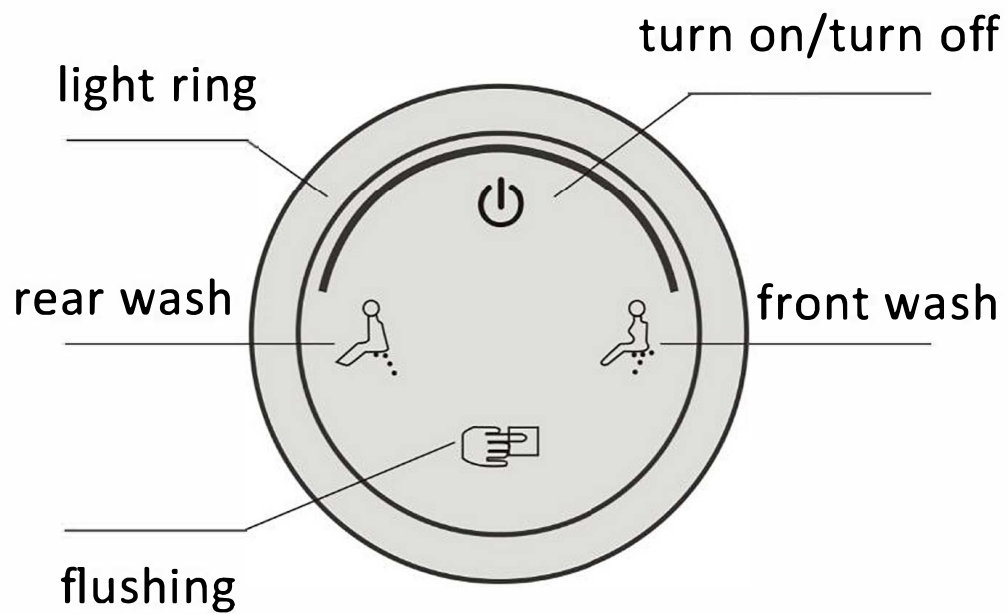



1. While in power off or stand-by mode, if pressing the knob, the buzzer rings, and the purple light (light ring in knob dial & top of toilet) is on, toilet startup.



2. While toilet startup, if pressing the knob, the buzzer rings, and the orange light (light ring in knob dial & top of toilet) is on, toilet starts to flush.



3. While seated or toilet is running rear wash, dry function, if turning the knob clockwise, the buzzer rings, and the pink light is on, toilet starts to front wash.

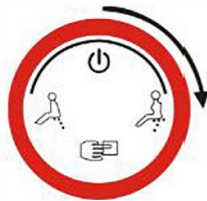

4. While toilet is running front wash, if turning the knob clockwise, the buzzer rings, and the red light is on, toilet starts to dry.

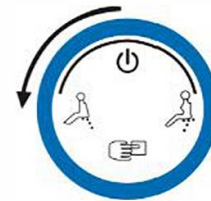

5. While seated or toilet is running front wash function, if turning the knob counterclockwise, the buzzer rings, and the blue light is on, toilet starts to rear wash.

INSTANT HEATING SYSTEM
National patent
The Sixth generation NH-3D
surround-sound



Fresh water instant heating
Persistent constant temp



SOFT OXYGEN KINETIC ENERGY TECHNOLOGY

Healthy and comfortable soft water wash
with soft bubble water, experience
moisture and oxygen skin

**SUPER SWIRL AND SILENCE
FLUSHING SYSTEM**



Clean and no remain, Enjoy quiet life

The new super-swirl flush tech changes the traditional way of
swirling. Super swirl pump contains water control system,
informer assistance, strong flushing, sealing system, strong
water flow, completely closed to back flow. Definitely
reduce the flushing noise to disarrange the family's sleep.

**ACTIVE OXYGEN PURE ENERGY
TECHNOLOGY**



Double filtration purifies odors,
decomposes bacteria, and effectively
rejuvenates indoor air

AIR PURIFIER IN BATHROOM

FEELING FLIP



According to the men's toilet habits,
designed for men, you just Stretch the foot
sensor to auto open up seat, make it easier
to use the toilet

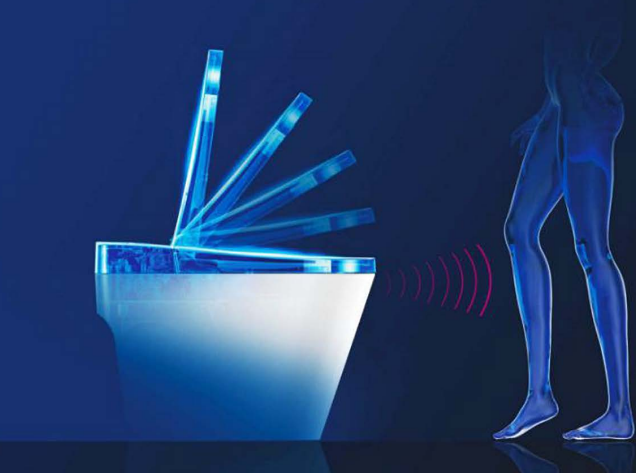

**AUTO INDUCTION
SYSTEM**

Auto open seat to release your hands

The new generation automatic radar wave induction tech
can accurately identify the human target, realize the
function of auto open seat or close, and completely release
your hands. Adopting international advanced tech and
double-sided damp to better control the stable rise of the
cover.

National patent
**NH-3D INSTANT HEATING
TECHNOLOGY**

The Sixth generation surround-sound
instant heating technology

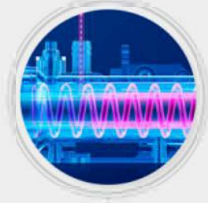

National patent
**SOFT OXYGEN KINETIC
ENERGY TECHNOLOGY**

Super soft bubble water
Experience moisture and oxygen skin



COME FROM **BEAUTY**
LIVE FOR **WISDOM**

Core-T



UVC-LED Medical grade
**UV STERILIZATION
TECHNOLOGY**

UVC deep ultraviolet physical
sterilization
Sterilization up to 99.99%



colorful science technology
ONE-KEY KNOB

One-button solution, complex into
simple, easy and convenient



316L stainless steel
**INTEGRATED CLEANING
NOZZLE**

The nozzle is made of 316L stainless
steel for the aviation industry
Add Mo element
Reject the growth of bacteria

National patent
**NH-3D INSTANT HEATING
TECHNOLOGY**

The Sixth generation surround-sound
instant heating technology

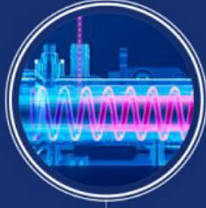

National patent
**SOFT OXYGEN KINETIC
ENERGY TECHNOLOGY**

Super soft bubble water
Experience moisture and oxygen skin



COME FROM **BEAUTY**
LIVE FOR **WISDOM**

Core-T



UVC-LED Medical grade
**UV STERILIZATION
TECHNOLOGY**

UVC deep ultraviolet physical
sterilization
Sterilization up to 99.99%



colorful science technology
ONE-KEY KNOB

One-button solution, complex into
simple, easy and convenient

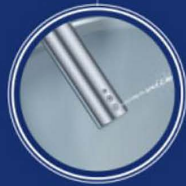

316L stainless steel
**INTEGRATED CLEANING
NOZZLE**

The nozzle is made of 316L stainless
steel for the aviation industry
Add Mo element
Reject the growth of bacteria



UV STERILIZATION NOZZLE

Give one more layer of health protection

Using UVC station, deep ultraviolet physical sterilization with wavelength of 275nm, the sterilization rate up to 99.99%, double sterilization after cleansing, much safer and cleaner.



FOOT SENSOR FLUSH

According to the men's toilet habits, designed for men, you can achieve the flushing function by stretching your feet. You don't need a remote control, you don't have to bend to press the button.



01
Bubble protection

02
Seat temperature protection

03
Drying temperature protection

04
Over flow rate protection

05
Anti dry heating protection

06
Anti freezing protection

07
IPX4 Anti water protection

08
Water temperature protection

09
V0 inflaming retarding protection

10
Power leakage protection

CARE WITH YOUR FAMILY
COME FROM BEAUTY LIVE FOR WISDOM