



Smart Toilet Installation Manual

- Thank you for choosing our products. Please read the instructions carefully before installation and keep it available for future maintenance or reference.
- The internal images in the manual are for reference only, and the actual product shall prevail.

CONTENTS



Installation	02
Cautions And Warnings	02
Technical Specification	07
Packing List	08
Part List	09
Toilet Installation	11
Before Using	16
Function Description	17
<hr/>	
Maintenance	22
Daily Maintenance	22
<hr/>	
Others	24
Troubleshooting Guide	24
Warranty Instructions	26





CAUTIONS AND WARNINGS

This appliance is not intended for use by persons (including children) with reduced physical, sensory or mental capabilities, or lack of experience and knowledge, unless they have been given supervision or instruction concerning use of the appliance by a person responsible for their safety.



Please read this statement thoroughly and ensure its proper use.
Strictly adhere to all written cautions and warnings provided.

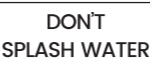



Meaning of the Marks:

-  **DON'T:** This symbol indicates a prohibited use of the product.
-  **MUST:** This symbol is used to indicate a required step in the use of this product.

 	<p>Never disassemble, repair or alter. Do not use tools in places other than designated.</p> <ul style="list-style-type: none"> • Doing so may cause fire, electrical shock, overheating, short circuit or breakdown.
 	<p>Do not get any water or cleaning solution on the main unit or connection of power cord.</p> <ul style="list-style-type: none"> • Doing so may cause fire, electrical shock, heat or short circuit. • Doing so may cause the product to crack resulting in injury or water damage.
 	<p>Do not use the product if a malfunction occurs.</p> <ul style="list-style-type: none"> • In case of breakdown or other problems, be sure to cut off power by flipping the power switch to OFF. Close the water shutoff valve to stop water supply. <p>Possible malfunctions:</p> <ul style="list-style-type: none"> • Water is leaking from a pipe or the main unit. • The product is cracked or broken. • The product makes a strange noise or emits a strange odor. • The product emits smoke. • The product is abnormally hot.

CAUTIONS AND WARNINGS

 DON'T	<ul style="list-style-type: none"> The toilet seat is out of place. Continued use of the product after a malfunction could result in fire, electrical shock, overheating, short circuit, injury, or water damage.
	<ul style="list-style-type: none"> Continued use of the smart toilet after a malfunction could result in fire, electrical shock, overheating, short circuit, injury, or water damage. Please contact professionals for assistance. The recommended service life of this smart toilet is 7 years. Please pay attention to the working conditions of the toilet after this period.
	<p>Use tap water only.</p> <ul style="list-style-type: none"> Using other types of water may cause irritation to the skin and malfunction of the product.
 STOP	<p>Do not use a loose or unstable power socket.</p> <ul style="list-style-type: none"> Doing so may cause fire or electrical shock.
	<p>Please insert the power plug into an AC socket rated for 110V to 60Hz and 15A or above. Failure to do so may result in fire or electrical shock.</p> <ul style="list-style-type: none"> If the power exceeds the socket's specification, it can cause the socket to overheat and start a fire.
	<p>Do not perform any actions that may damage the power plug. Avoid striking, yanking, twisting, excessively bending, damaging, altering, or heating the power cords. Additionally, do not place any heavy objects on, bind, or pinch the power cords.</p> <ul style="list-style-type: none"> Using a damaged power cord may result in a fire, electrical shock, heat or short.
 MUST	<p>This is an electrical product. Do not install it anywhere water is likely to get on the product or anywhere with humidity high enough that water is likely to form on the surface of this product. When using the product in a bathroom, install a fan or ventilation port and ensure good air flow through the bathroom.</p> <ul style="list-style-type: none"> Failure to do so may cause fire or electrical shock. <p>If the power cord is damaged, avoid danger by having the manufacturer's repair department or equivalent specialist replace it.</p>

 MUST	<p>If the supply cord is damaged, it must be replaced by the manufacturer, its service agent or similarly qualified persons in order to avoid a hazard.</p>
	<p>Children being supervised not to play with the appliance.the appliance is not to be used by persons (including children) with reduced physical, sensory or mental capabilities, or lack of experience and knowledge, unless they have been given supervision or instruction.</p> <ul style="list-style-type: none"> To prevent from low-temperature burns, please do not sitting on the toilet for a long time.
 GROUND WIRE	<p>This appliance must be grounded.</p> <p>Connect this product only to a properly grounded power supply unit (device).</p> <ul style="list-style-type: none"> Improper connection may cause electric shock.
 MUST OBEY	<p>Do not raise the toilet seat or lid while objects are resting on top of the unit.</p> <ul style="list-style-type: none"> Doing so may cause the main unit to come loose and fall, resulting in injury. <p>Do not lean on cover when use this device to prevent product from damage.</p>
 NO FIRE	<p>Keep cigarettes and other open flames away from the product.</p> <ul style="list-style-type: none"> Failure to do so may cause fire.
 STOP	<p>Do not apply strong force, mechanical shock, step on or stand on the toilet seat, toilet lid or main unit. Also do not place any heavy objects on the toilet seat, toilet lid or main unit.</p> <ul style="list-style-type: none"> Doing so may cause cracking or cause the main unit to come loose and fall, resulting in injury. Doing so may damage the product and cause injury or water damage.
	<p>Never obstruct the warm air openings of the product with fingers or any other items.Ensure that the warm air openings remain unobstructed to prevent electric shock, personal injury, or damage to the product.</p>

CAUTIONS AND WARNINGS

	<p>Do not fold or crush the water supply hose; do not damage by cutting with a sharp object.</p> <ul style="list-style-type: none"> • Doing so may cause water leaks. <p>When maintaining the plastic parts (main unit etc.) or the water supply hose, use a neutral kitchen detergent diluted with water. Do not use any of the following: toilet cleaner, household cleaner, benzene, paint thinner, powdered cleanser, or nylon scrubbing brush.</p> <ul style="list-style-type: none"> • These items may damage or crack the plastic, potentially causing injury or malfunction. • Additionally, these items could damage the water supply hose and result in a water leak. <p>To prevent a sudden water leak, never remove the water filter drain valve while the shutoff valve is open.</p> <ul style="list-style-type: none"> • Doing so will cause water to spurt out unexpectedly.
<p>STOP</p>	<p>When installing the water filter drain valve, make sure that it is securely tightened in its proper position.</p> <ul style="list-style-type: none"> • Failure to securely tighten it may cause a water leak.
	<p>If a water leak occurs, always close the shutoff valve immediately.</p>
<p>MUST OBEY</p>	<p>When the ambient temperature is expected to drop to 0°C or below, take measures to prevent damage to the pipes and hoses due to freezing.</p> <ul style="list-style-type: none"> • Frozen water pipes can cause the main unit and connected pipes to crack, potentially resulting in a water leak. • To avoid this, regulate the room temperature to ensure that the pipes and hoses do not freeze during cold months. • Failure to properly secure and tighten connections may also cause a water leak. <ul style="list-style-type: none"> • Avoid exposing the product to direct sunlight, as this may cause changes in color or malfunction. • Do not urinate on the main unit, toilet seat, or wand, as this may result in failure or discoloration.

	<ul style="list-style-type: none"> • Disconnect the power cord during thunderstorms. • When the product will not be used for a long period of time, close the shutoff valve and then turn off the power to the product. • When the product is not used for a long time, remove the battery in the 16V battery box to prevent the battery leakage from damaging the battery box.
<p>MUST OBEY</p>	<ul style="list-style-type: none"> • The required water pressure should be between 0.18MPa and 0.5MPa. • Use the water supply hose provided with the product. Old water supply hoses cannot be used.
	<ul style="list-style-type: none"> • During daily use of the remote control, keep it away from water to prevent water from getting inside the remote control. And please return it to the holder after each use. • When the product has been used for a long period of time, replace the batteries in the remote control.

TECHNICAL SPECIFICATIONS

Product Name	Smart Toilet
Rated Voltage	110-120V
Rated Frequency	60Hz
Rated Power	1150W
Flush Volume	1.28GPF(4.8LPF)
Waterproof Level	IPX4
Warm Water Temperature	4 levels (Room Temperature- 104°F)
Warm Air Temperature	4 levels (Room Temperature- 140°F)
Heated Seat Temperature	4 levels (Room Temperature- 105°F)
Operating Temperature	41-104°F
Warm Water Heating Method	Instant Heating
Water Entry Temperature	33.8-95°F
Supply Water Pressure	11.6-73 PSI (0.08MPa-0.5MPa)
Codes/Standards	ASME A112.19.2-2018/CSA B45.1-18 ASME A112.4.2-2021/CSA B45.16:21

*Power value testing condition:

Water Pressure: 29 PSI (0.2 MPa), Inlet Water Temperature: 59°F.

Water Flow: 0.17 gpm (650 ml/min).

- Maximum temperature of the water supplied by the product for hygiene purposes: 107°F.
- No further notice will be provided if any technical specifications change due to product improvement or technical updates. All actual technical specifications are subject to the final product.

PACKING LIST

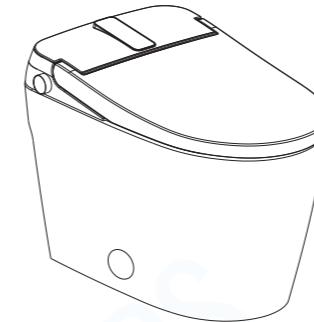

Main Unit

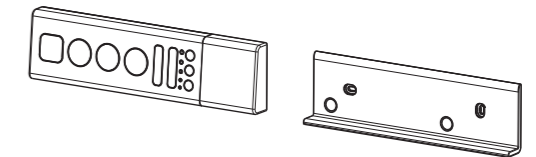

Remote Control Components

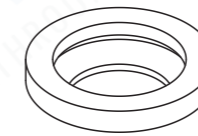

Wax Ring

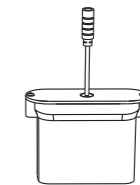

16V Battery Box (Battery excluded)

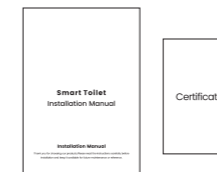

Installation Manual and
Certificate Of Competency



1/2 inch-to-9/16
inch Adapter

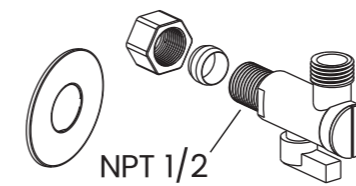

Angle Valve

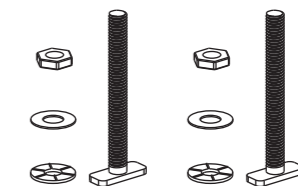

T-bolts



Decorative covers

PART LIST

Left side

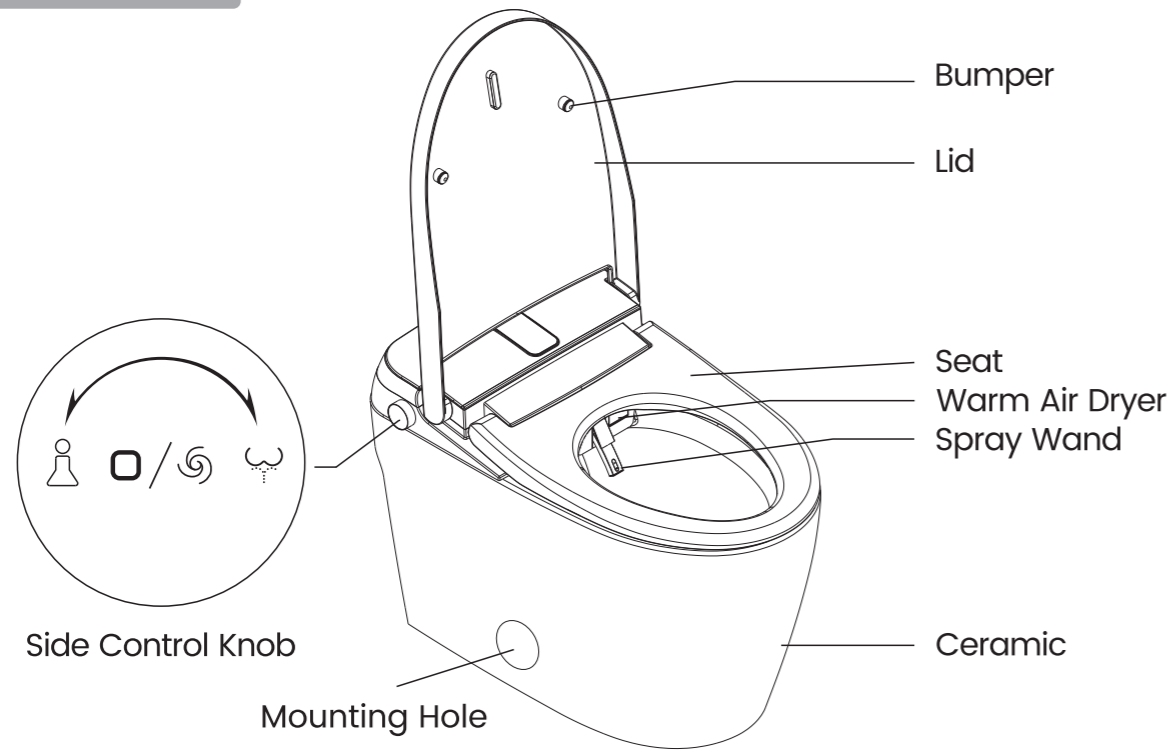

Right side

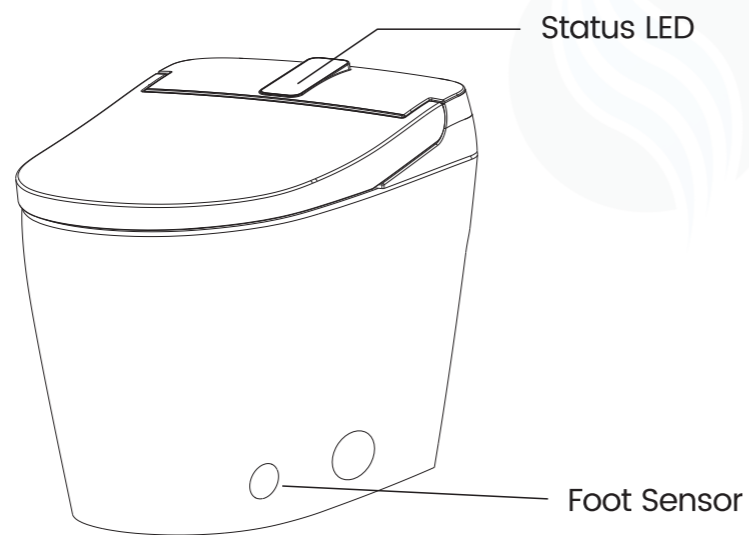

Remote Control

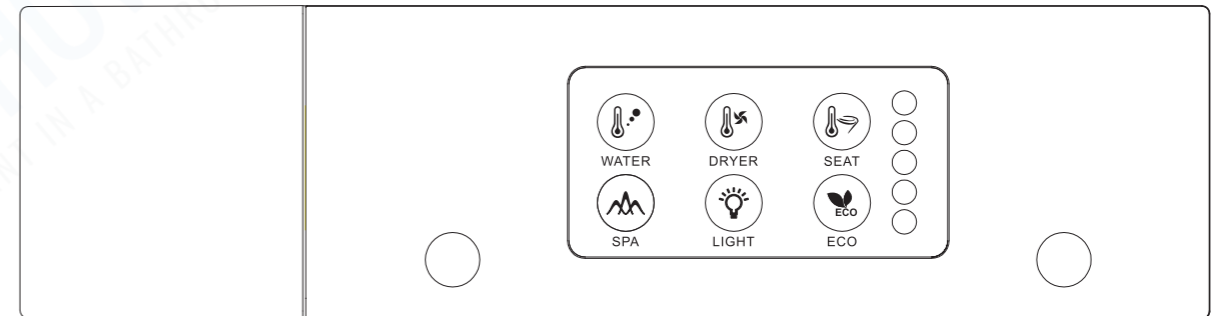
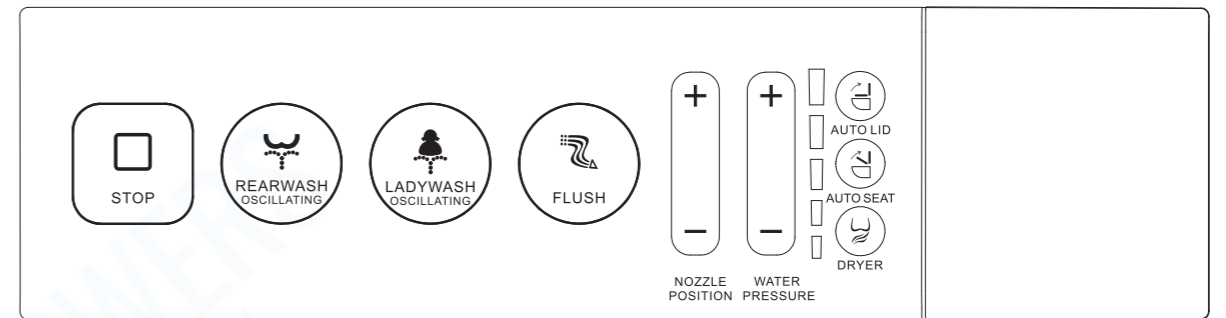

Meanings of the icon on the remote control

STOP	WATER PRESSURE INCREASE	AUTO LID
REARWASH OSCILLATING	WATER PRESSURE DECREASE	AUTO SEAT
LADYWASH OSCILLATING	NOZZLE POSITION MOVE FORWARD	WATER
DRYER	NOZZLE POSITION MOVE BACKWARD	SEAT
FLUSH	LIGHT	DRYER AIR TEMP
SPA	ECO	

• The product drawing is for reference only, and we reserve the right to modify the appearance of the product. If the appearance of the product is changed, the actual product shall prevail.

TOILET INSTALLATION

Required Tools:

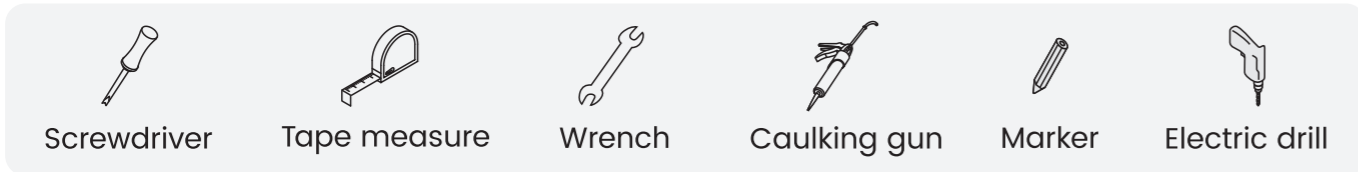

Installation Diagram:

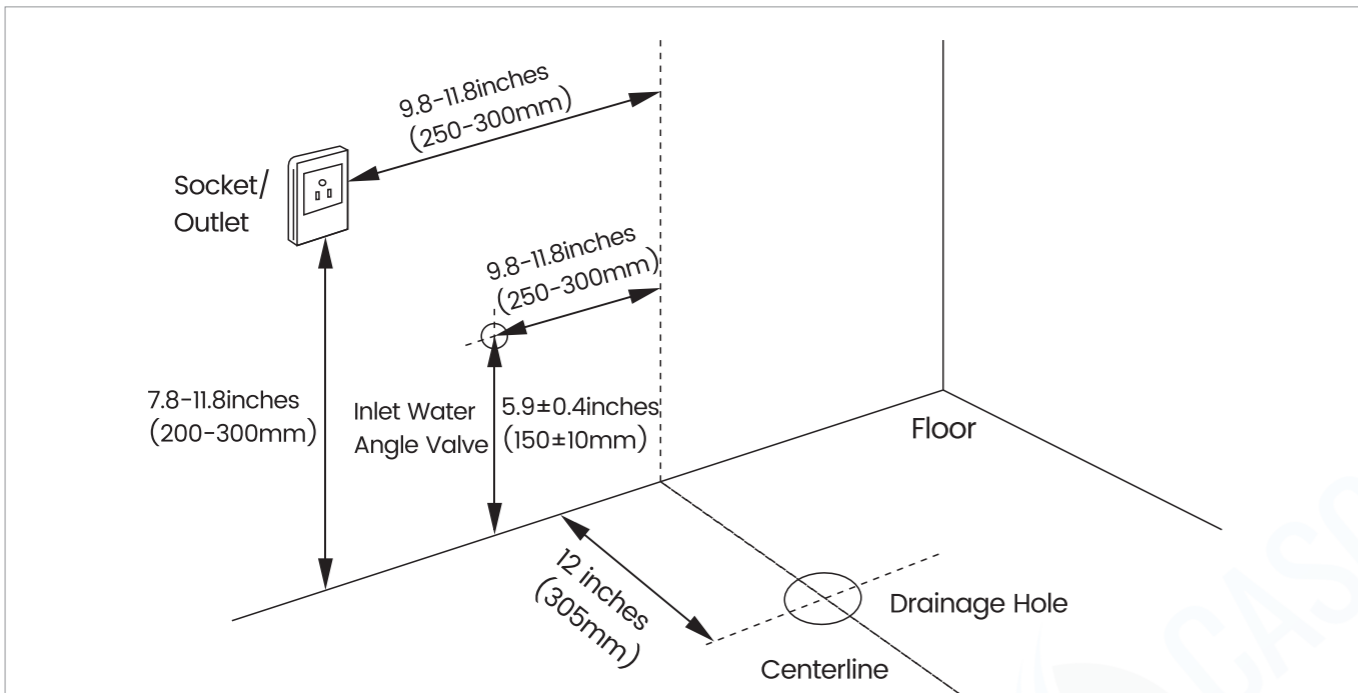

⚠ WARNING

Power Outlet Installation Instructions:

- Ensure that the power outlet is properly grounded in accordance with applicable electrical codes.
- The power cord should have a length of 1.5 meters. The location of the power outlet should be in close proximity to facilitate the installation and disassembly of this product, while also maintaining a safe distance from the bathtub area.
- It is strongly recommended to use a waterproof-type outlet. Do not use extension cords to connect this product. Failure to follow these instructions could result in fire or electrical shock.

Pre-Installation Precautions:

- Before installation, flush the pipe with water for 1 minute to remove any impurities remaining in the pipeline.

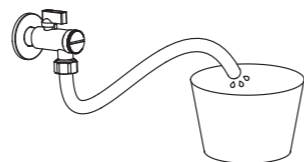

Installation Steps:

1. For a newly installed toilet in the bathroom, a flange plate needs to be added. (Flange plate is not included and installer has to purchase it for proper installation.)

- Place the flange plate into the drainage hole, aligning the arrow on the flange plate with the dashed line on the vertical wall. The center of the flange must align with the center line.
- Use a marker to indicate the positions of the four installation holes on the flange plate.
- Use an electric drill to create four $\varnothing 6\text{mm}$ installation holes on the flange plate. Insert four corresponding plastic anchors.
- Secure the flange plate in place using the provided four screws.

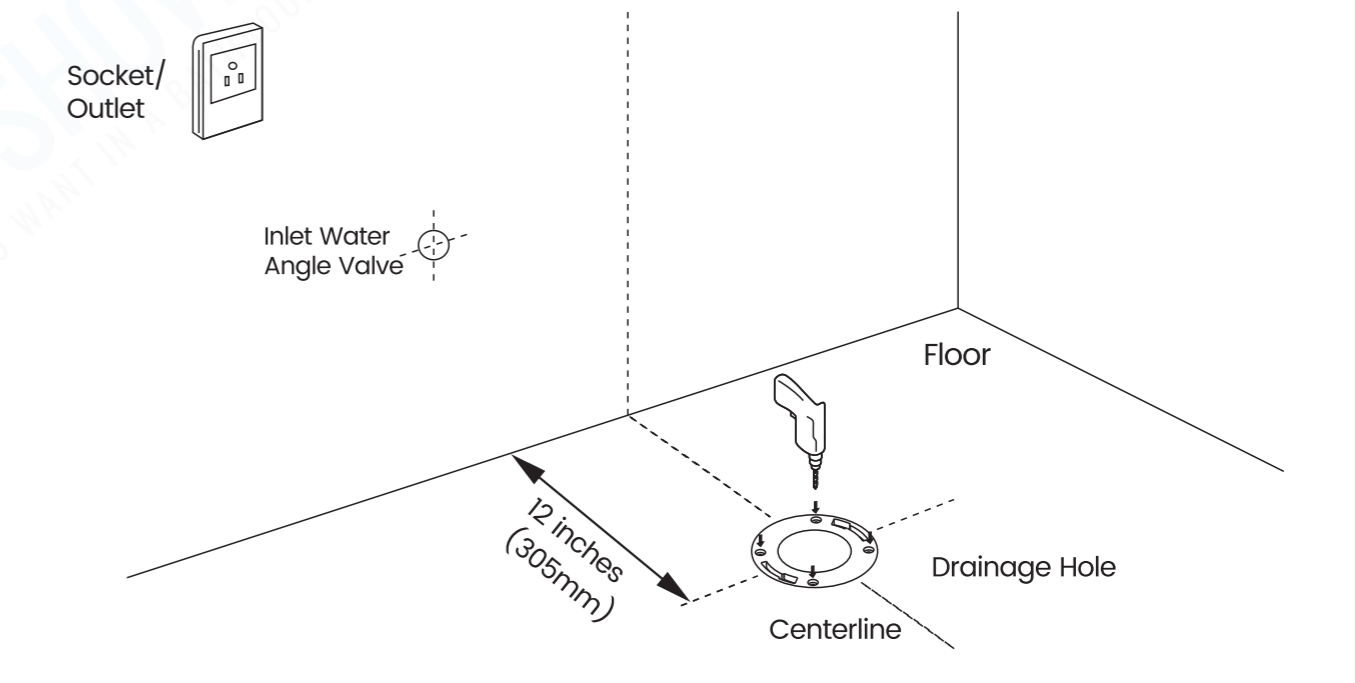

2. Install the floor bolts

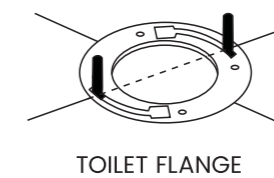
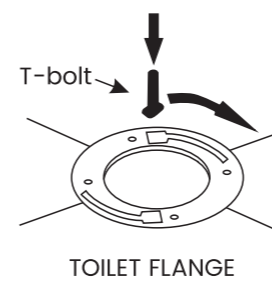

Note: The two screws and the center of the flange must be in a straight line

TOILET INSTALLATION

3. Install angle valve

3.1 Installation Method 1:

3.1.1 Remove the copper sleeve and nut from the NPT 1/2 valve.

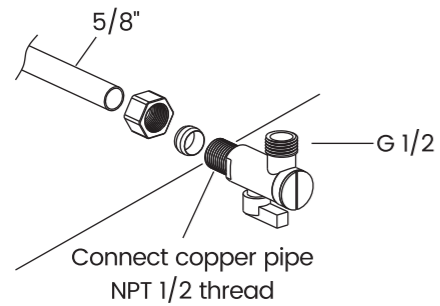

3.1.2 Insert the nut and copper sleeve into the copper tube in sequence, and then tighten the valve.

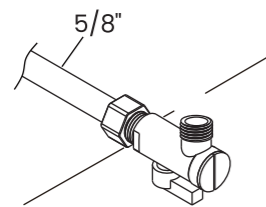

3.2 Installation Method 2:

3.2.1 Remove the copper sleeve and nut from the NPT 1/2 valve.

3.2.2 Turn the valve into the water outlet.

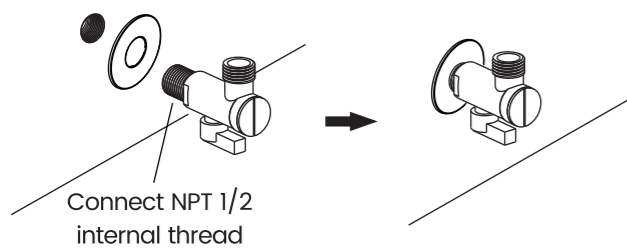

3.3 Installation Method 3:

3.3.1 Wrap sealing tape around the NPT 9/16 thread of the valve and screw the end of NPT 9/16 onto the valve.

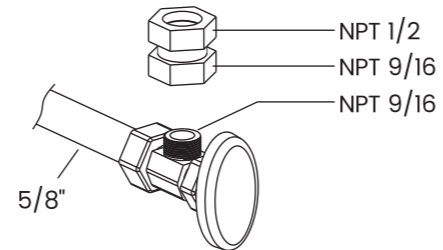

3.3.2 Remove the copper sleeve and nut from the NPT 1/2 valve.

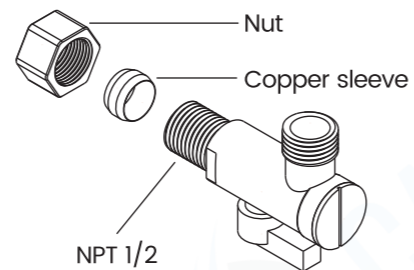

3.3.3 Wrap sealing tape around the NPT 1/2 thread of the valve, and then tighten the valve joint NPT 1/2 location.

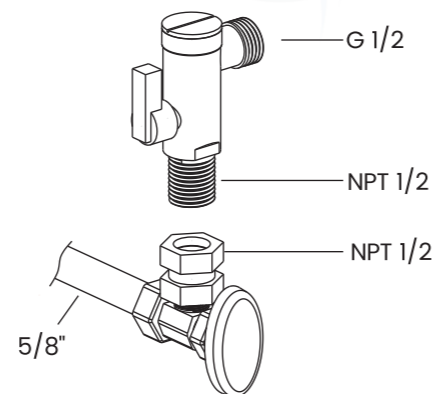

4. Install battery

Open the battery compartment and insert 10 AA batteries. Find the lead wire of the battery box, connect the waterproof plug, and then place the battery box inside the ceramic.

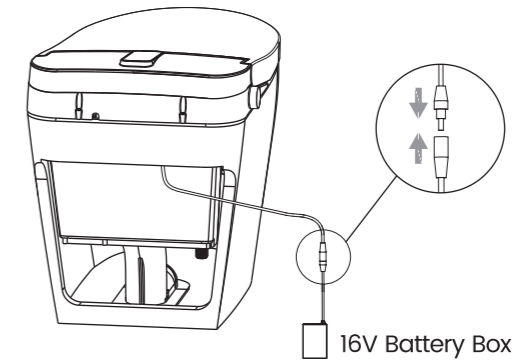

5. Install the wax ring

Put the wax ring on the flange.

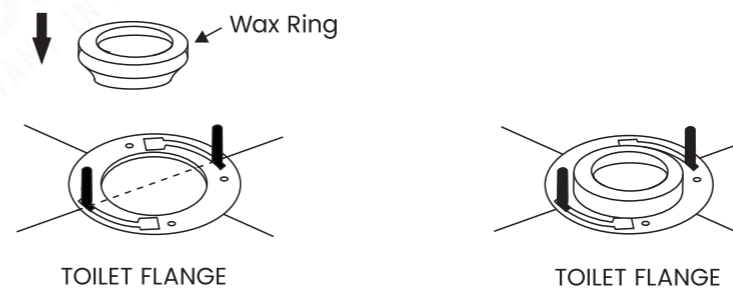

6. Install the toilet

Carefully lower the toilet onto the flange and press firmly to secure it.

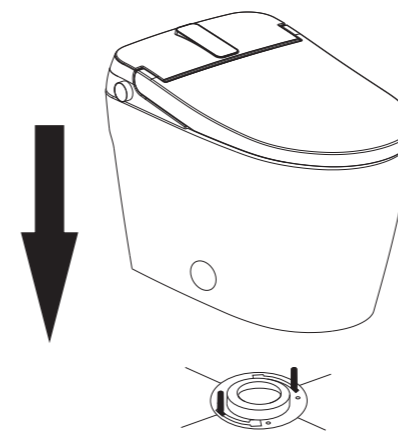

Place the washer and nut onto the T-bolt screw, then tighten securely.

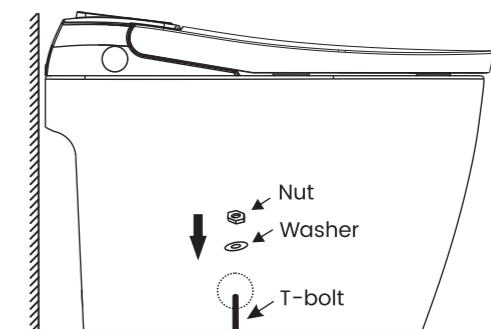

TOILET INSTALLATION

7. Install decorative cover

Cover both sides of the toilet with decorative covers.

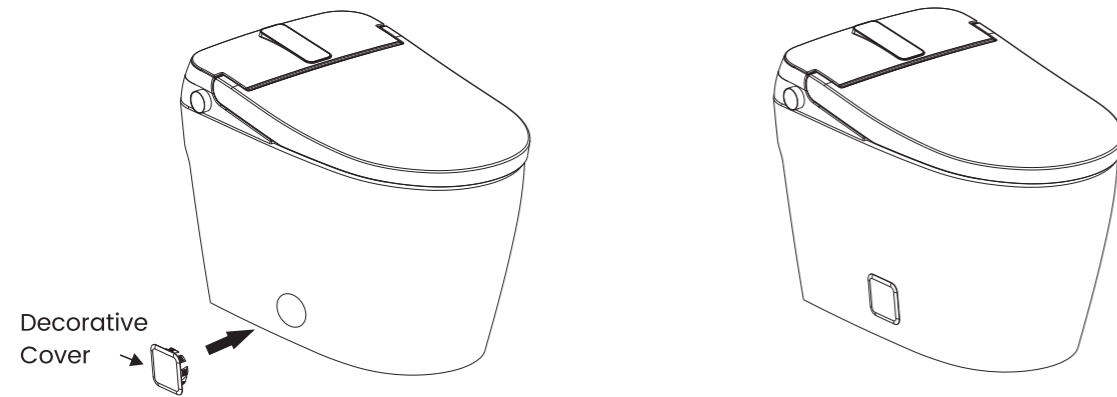

8. Connect the inlet pipe

8.1 Connect the water inlet hose.

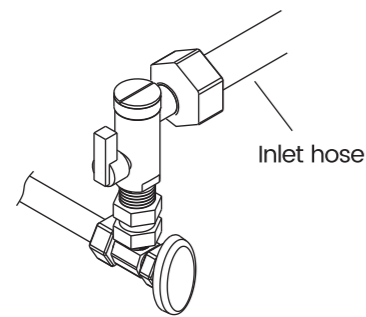

8.2 Apply a circle of anti-mold sealing silicone at the junction between the toilet and the floor. After the silicone sealant has solidified, plug in the power and slowly open the angle valve. Adjust the water pressure to within 80 PSI and check all connection points for leaks.



BEFORE USING

1. Turn on the angle valve

- Check the threaded connection to ensure there are no leaks.
- Unscrew the angle valve counterclockwise to fully open it.

(Tips: When opening the angle valve for the first time, the handle may require more torque.)

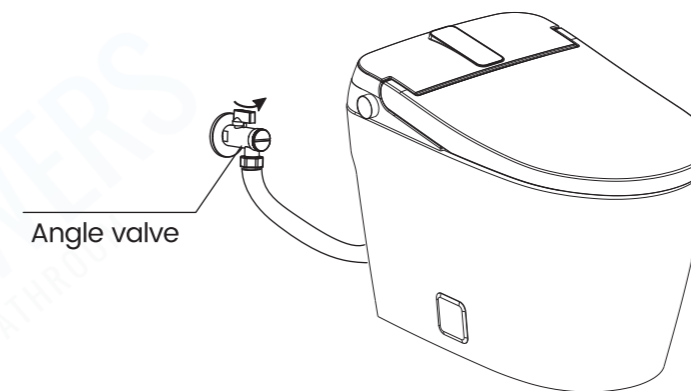

2. Power Connection

Insert the leakage protection plug into the power socket. Press the reset switch. The plug indicator lights up, indicating that the power is on.

Tips:

- Before usage, press the electric leakage test button. The reset switch should pop up, indicating that the leakage protection function is normal.
- Press the TEST button (then the RESET button) every month to ensure proper operation.

Note: Only applicable for models equipped with a leakage protection plug. Please refer to the actual product for details.

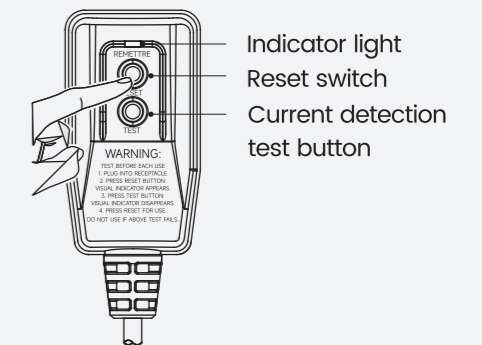

3. Self-inspection

- The main unit buzzer rings "beep".
- After another "beep" from the buzzer, self-inspection is complete.
- Proceed to normal function mode for regular usage.

FUNCTION DESCRIPTION

	<h3>Rear Wash/Oscillating</h3> <p>Rotate the control knob to the "REAR WASH" mode, or press the "REAR WASH" button on the remote control. Activation of the water spray from the rear outlet of the wand will occur. Press the button again to activate the "OSCILLATING" mode, in which the washing area is expanded, and the water moves forward and backward. The washing function will automatically cease after 2 minutes.</p>
	<h3>Lady Wash/Oscillating</h3> <p>Rotate the control knob to the "LADY WASH" mode, or press the "LADY WASH" button on the remote control. Activation of the water spray from the front outlet of the wand will occur. Press the button again to activate the "OSCILLATING" mode, in which the washing area is expanded, and the water moves in a forward and backward motion. The washing function will automatically cease after 2 minutes.</p>
	<h3>Warm Air Dryer</h3> <p>The warm air dryer should be used after cleansing. Press and hold the knob for 3 seconds or press the "DRYER" button to activate the warm air dryer. The warm air dryer feature will automatically shut off after 3 minutes.</p>
	<h3>Flushing By Remote Control</h3> <p>Press the "FLUSH" button to manually flush the toilet. Press the "FLUSH" button twice quickly to initiate a low-volume water flush.</p>
	<h3>Water Temperature</h3> <p>Press the "WATER" button to adjust the cleaning water temperature. Press the first time to show current water temperature. Press again to change the water temperature into suitable level.</p> <ul style="list-style-type: none"> • There are 4 levels of water temperature (close/around 93°F- 104°F).
	<h3>Warm Air Temperature</h3> <p>Press the "DRYER" button to adjust the air dryer temperature. Press the first time to show current air temperature. Press again to change the air temperature into suitable level.</p> <ul style="list-style-type: none"> • There are 4 levels of air temperature (close/around 122°F- 140°F).

	<h3>Seat Temperature</h3> <p>Press the "SEAT" button to adjust seat temperature. Press the first time to show current seat temperature. Press again to change the water temperature into suitable level.</p> <ul style="list-style-type: none"> • There are 4 levels of air temperature (close/around 91°F- 105°F).
	<h3>Stop</h3> <p>Press "STOP" button to terminate the function of "REAR WASH/LADY WASH/DRYER".</p>
	<h3>Auto Open/Close Lid (This feature is unique to the automatic open lid model)</h3> <p>Press the "AUTO LID" button on the remote control to open/close lid.</p>
	<h3>Auto Open/Close Seat (This feature is unique to the automatic open lid model)</h3> <p>Press the "AUTO SEAT" button on the remote control to open/close seat.</p>
	<h3>Hot And Cold Water Massage</h3> <p>Press the "SPA" button briefly during the cleansing feature to activate the massage, which alternates hot and cold water. Press the "STOP" icon to terminate all features.</p>
	<h3>Pulsate Massage</h3> <p>Press and hold the "SPA" button for 3 seconds during the cleansing feature to activate the pulsate massage, with water pressure changing alternately. Press the "STOP" icon to terminate all features.</p>
	<h3>Night light</h3> <p>Press the "LIGHT" icon on the remote control to open or close the nightlight.</p>

FUNCTION DESCRIPTION

Adjusting Water Pressure

[+ (water pressure increase) / - (water pressure decrease)]

Press the " + " or " - " icon to increase or decrease water pressure.

Adjusting Nozzle Position

[+ move forward / - move backward]

Press the " + " or " - " icon to adjust the wand position through 3 settings.

Deodorizer

Activated carbon deodorization. Automatic operation, no manual intervention needed.

Energy Saving Mode

When the intelligent toilet is not used for 1 hour, it will automatically enter energy-saving mode, and the seat temperature will automatically adjust to 91°F, entering a low-temperature setting. Upon being seated, it will reheat to the preset temperature.

Motion sensor flip (toilet) seat cover

(This feature is unique to the automatic flip toilet)

- Motion sensor flip (toilet) seat cover Open and close the seat cover by identifying the proximity/presence/departure of the human body;
- When the human body is approximately 30-60cm away from the toilet, the cover will automatically open.
- When the cover is opened, it will automatically close 30 seconds after the human body departs.
- When the seat is lifted, both the seat and the toilet cover will automatically close and initiate a water flush upon the departure of the human body.
- If the flushing function has already been activated during use, no additional flushing will occur after the cover is closed.

Foot Kick Flip the Cover And the Seat

(This feature is unique to the automatic flip toilet)

- When the cover is closed, kick the foot kick, it will automatically open the cover;
- When the cover is opened/the seat is closed, kick the foot kick, it will automatically open the seat;
- When the seat is opened, kick the foot kick, it will automatically close the cover, the seat and then flush.

Automatic Flush After Leave

When the human body is seated for at least five seconds, it will automatically flush after leaving the seat.

Power Outage Flushing

The toilet is equipped with a backup battery. In the event of a power outage, short press the knob to activate the flushing function.

Toilet Bowl Moisture

When the toilet is in standby mode, please follow these steps to activate the moisture function:

- To toggle the 'Toilet Bowl Moisture' function, rotate and hold the knob to the 'REAR WASH' position for 3 seconds until you hear a beep.
- Within 2 seconds after the beep, press the 'FLUSH' button on the remote control.
- Please ensure that all steps are followed correctly for proper activation of the moisture function.

Pairing the Remote Control to the Toilet

- On standby mode, rotate the knob towards the "REAR WASH" direction and hold it for about 3 seconds. After hearing the prompt sound, release it. Wait for about 2 seconds before hearing the prompt sound again, indicating that the remote control has entered the code matching mode. Press any button on the remote control to successfully match the code.
- Each remote control corresponds to a unique address code. Before using the designated toilet, it is necessary to pair the remote control once in order to use it. Otherwise, the remote control will not operate.

FUNCTION DESCRIPTION

Control Knob:

There are 4 functions of the side control knob: **[Dryer/Flush]**, **[Rear Wash]**, **[Lady Wash]**, **[Stop]**.

When the toilet is not occupied:

- Press the knob to flush.
- Press and hold the knob for 5 seconds to power on/off the toilet.

When the toilet is occupied:

- Turn the knob clockwise to activate spray wand and start rear wash.
- Turn the knob anti-clockwise to activate spray wand and start lady wash.
- Press and hold the knob for 3 seconds, the toilet will first activate the flushing function before drying.
- One-Key Mode: Turn the knob towards the Rear Wash/ Female Wash direction and hold for 3 seconds to activate the one-key mode. The product will automatically perform the following steps: Rear Wash/ Female Wash → Flushing → Drying.

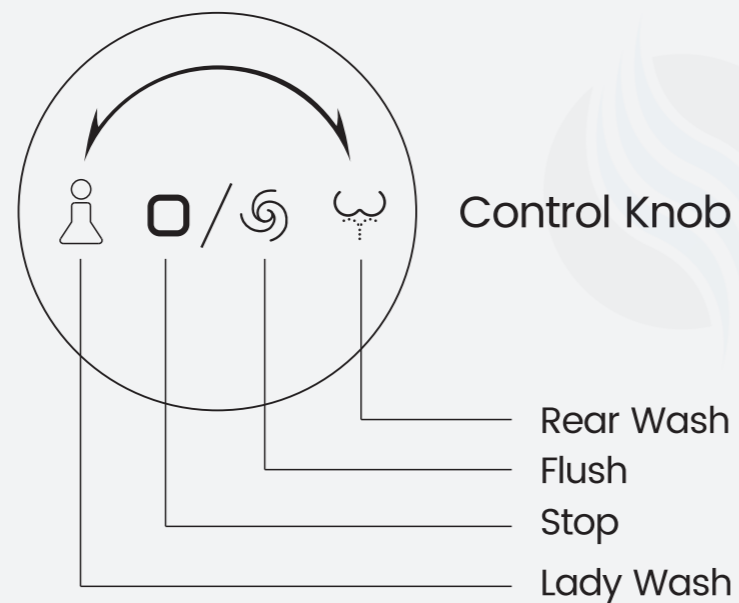

DAILY MAINTENANCE

Main unit care and maintenance

1. Shut off power supply before doing maintenance.
2. Wipe the stain with a soft damp cloth.

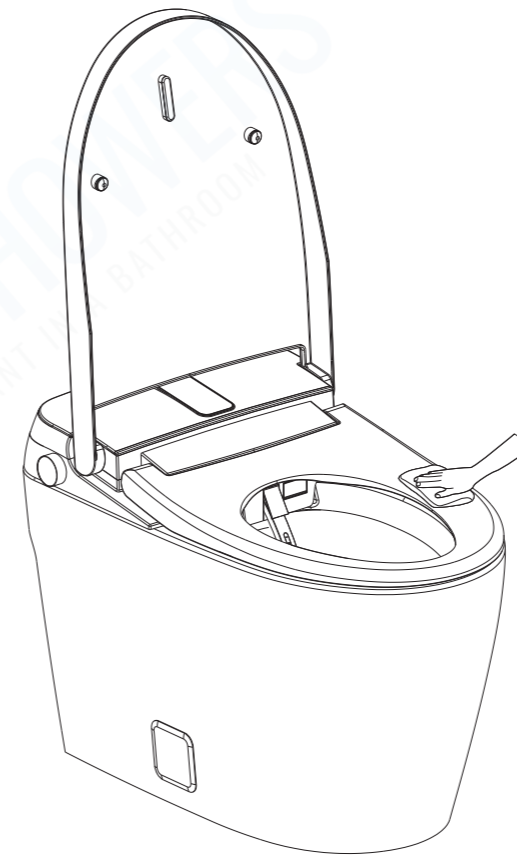

3. After cleaning, re-connect the toilet with the power supply.

Maintenance of filter net

Maintenance is required when the system is under normal water pressure but experiencing poor flush performance.

1. Turn off power and the angle valve.
2. Unscrew angle valve nut.

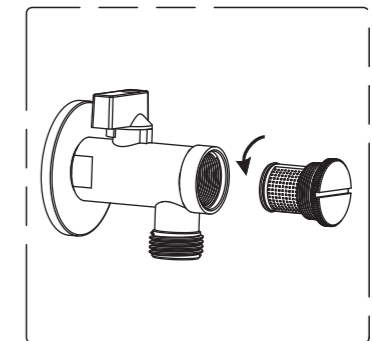

3. Use a brush to clean filter net.

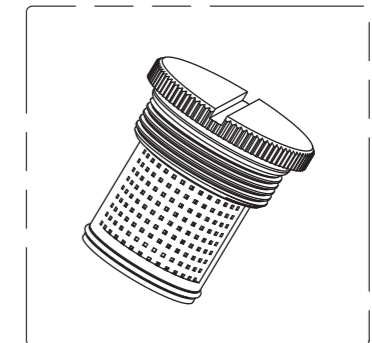

4. Reinstall filter net.
5. Turn on the angle valve and connect power, then it can work normally after self inspection.

DAILY MAINTENANCE

Spray nozzle maintenance and care

When there are stains on the nozzle:

1. Open the cover and seat;

2. With the product connected to water and electricity, rotate the knob towards the lady wash direction and hold it until you hear the prompt sound. This will extend the nozzle and clean water will flow from the self-cleaning port.

3. Gently brush the nozzle with a small brush;

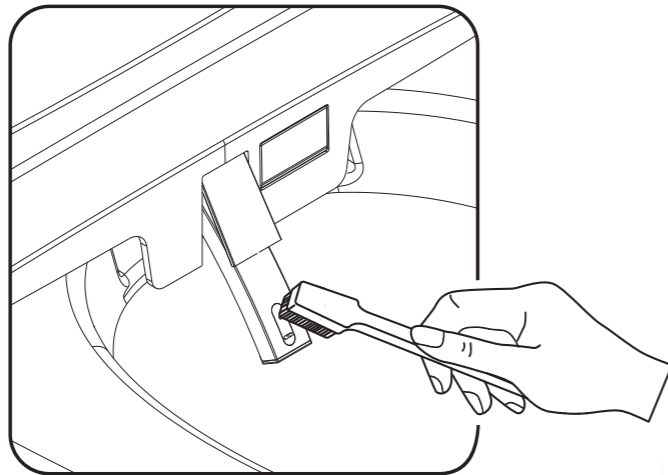

4. Short press the knob or press the "STOP" button on the remote control to retract the nozzle.

TROUBLESHOOTING GUIDE

Problem	Cause	Solution
No Water from Nozzle	Water inlet hose bent to cause blocking	Solve the problem of bending of water inlet hose
	Inlet valve is off	Turn on the inlet valve
	Water supply is cut off	Connect water supply and wait for the water
	The sensor does not work	Change your seated gesture to make sure sensor is on work
Weak water cleaning	Water inlet hose bent to cause partial blocking	Solve the problem of bending of water inlet hose
	Inlet valve is not fully turned on	Turn on the inlet valve fully
	Inlet filter blocked	Clean the filter
Low water temperature	The water temperature is setted on normal temperature level	Reset the water temperature
Low seat temperature	The seat temperature is setted on normal temperature level	Reset the seat temperature
Low wind temperature	The wind temperature is seton normal temperature level	Reset the wind temperature
Stops in the middle of use	Dryer features stop automatically after 3 minutes of continuous use	Restart the dryer function
	Cleansing features stop automatically after 2 minutes of continuous use	Restart the Cleansing function
	Seat sensor faile to sense people presence	Change the position you seat, makesure the sensor is on
Spray rod cannot retracted	Power off	Push back the rod lightly and wait for the power
	Get stuck by impurities	Clear away the impurities

TROUBLESHOOTING GUIDE

Problem	Cause	Solution
Spray rod cannot extend	Power is off	Gently push the spray rod forward and wait for the power to be restored
	Not seated in the sensing area	Sit properly within the sensing area
Remote control display not functioning	Battery polarity reversed	Reinsert the battery with correct polarity
Toilet leaking	Close the angle valve, inspect all water pipes, and contact a professional.	
 Caution	If the problems cannot be resolved using the methods above, please shut off the power and contact service providers for maintenance.	
	If the leakage circuit breaker frequently trips, indicating electrical leakage, shut off the power and contact the service provider for maintenance.	

Warranty Instructions

If you encounter any malfunction during use, please stop using the product immediately and unplug it. You can directly call our nationwide after-sales service hotline, and our after-sales staff will contact you as soon as possible.

Warning

If the user contacts an unauthorized third-party repair service, any consequences resulting from such action shall be borne by the user.

Product Warranty Regulations

1. If a malfunction occurs within one year from the date of purchase due to proper use, please contact after-sales service and provide the product's SN code or the invoice as valid proof.

2. Situations not covered under the free repair service within the warranty period include:

- ① Damage caused by improper use or storage by the user;
- ② Damage caused by self-installation or self-repair by the user;
- ③ Inability to present valid proof (neither an invoice nor a product SN code), or if the proof is unclear, unverifiable, or has been altered;
- ④ Damage caused by force majeure (e.g., typhoons, snowstorms, hail, earthquakes, mudslides, etc.);
- ⑤ Damage caused by transportation, unloading, or compression.

3. For products that require repair and support after the warranty period has expired, a service fee, labor fee, and material fee will be charged accordingly.

Warranty Receipt

The following receipt is an important proof of warranty. Please do not remove it by yourself.

Product Model:

Dealer:

Purchase Date:

Serial Number:

User Name:

Contact Number:

Purchase Date:

Address:

Repair Date:

Service Type: On-site Service Drop-off Repair

Repair Technician:

Service Center:

Repair Date:

Repair Details:

Fault Description:

Repair Technician:

Repair Details:

Cause of Fault:

Product Barcode:

User Signature: