

Installation Manual

For 23"x31" LED Shower Head No Mist with 2" Body Jets

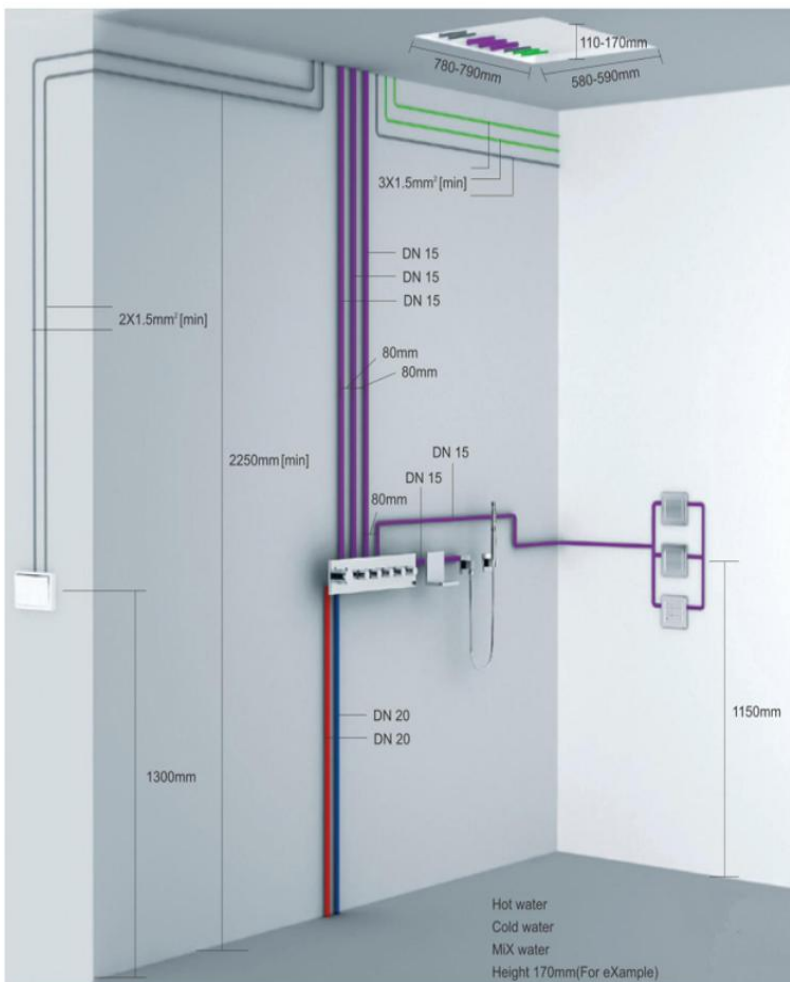

Project Condition

Requirements of bathroom

1. Wet and dry area must be separated and the electronic switch should must be installed in dry area.
2. The area of bathroom should be watertightness and decorated by anti-skidding tile.

Project Condition

Requirements of building

3. Ceiling thickness should be strong enough to install the 3201 luXurious shower head which net weight is 25KG and reaches above 35KG when shower.
4. Ceiling height should be above 2.3M that can not affect the shower and the aesthetic effects.
5. Wall thickness should be above 15CM that make sure the pre-hidden and installation of faucet.

Requirements of drainage

6. Water supply

The biggest work pressure: 0.8Mpa The perfect work pressure: 15 °-65 °
The highest water temperature: 70C ° The perfect water temperature: 15C°-65C°

The number of shower people is determined the lowest hot water supply that everyone can fully enjoy the shower.

The lowest hot water supply of this shower system should be at least above 250L.

7. The connection pipe of input and output water.

Two 3/4 (cold, hot) input water pipe Five 1/2 mixed water output pipe.

Attention: All water pipe must be washed the deposit before connect all components of shower system (faucet, shower head and body shower) in order to avoid damage and block.

8. Drainage system

The lowest tonnage of drainage system is above 60L.

Requirements of power

9. Power line : 5X1.5mm

10. Power control switch must be installed in dry area.

Note: Install power fault protection device with 30MA rated current and there is inside power transformer (Change to 12V safe power) of LED shower head.

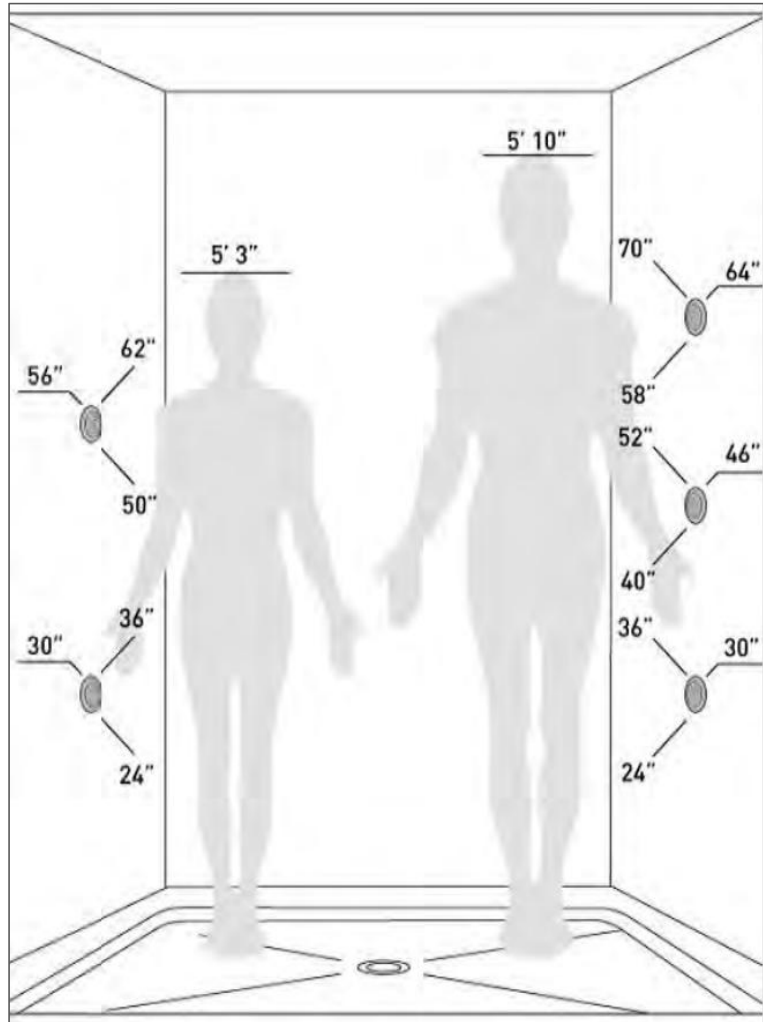
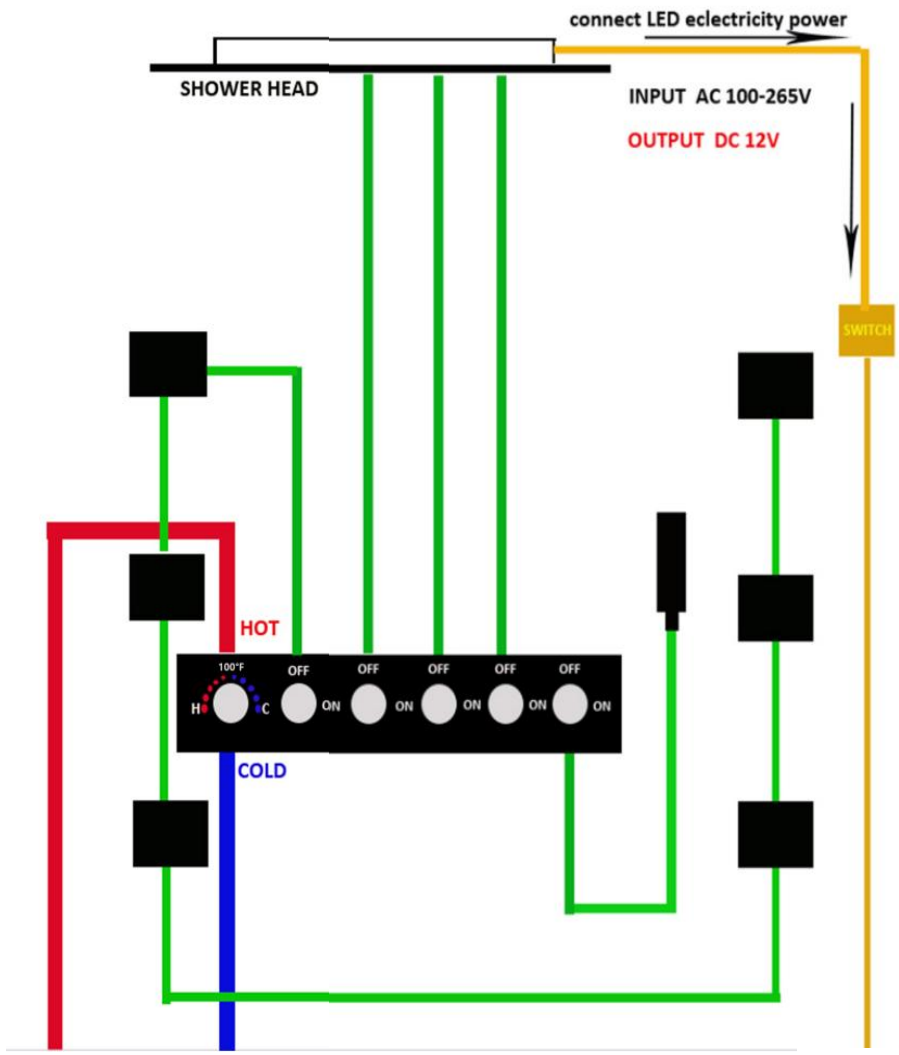

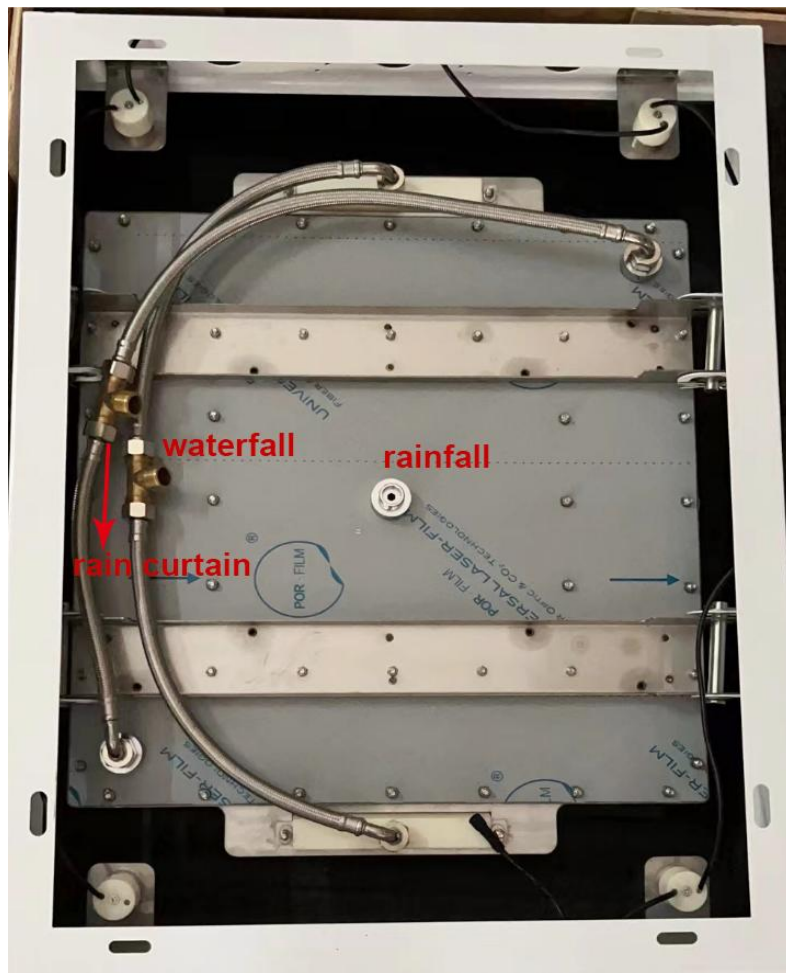

Actual photo
for a shower
system with
7-knob valve
for
reference:



Shower Head Installation:

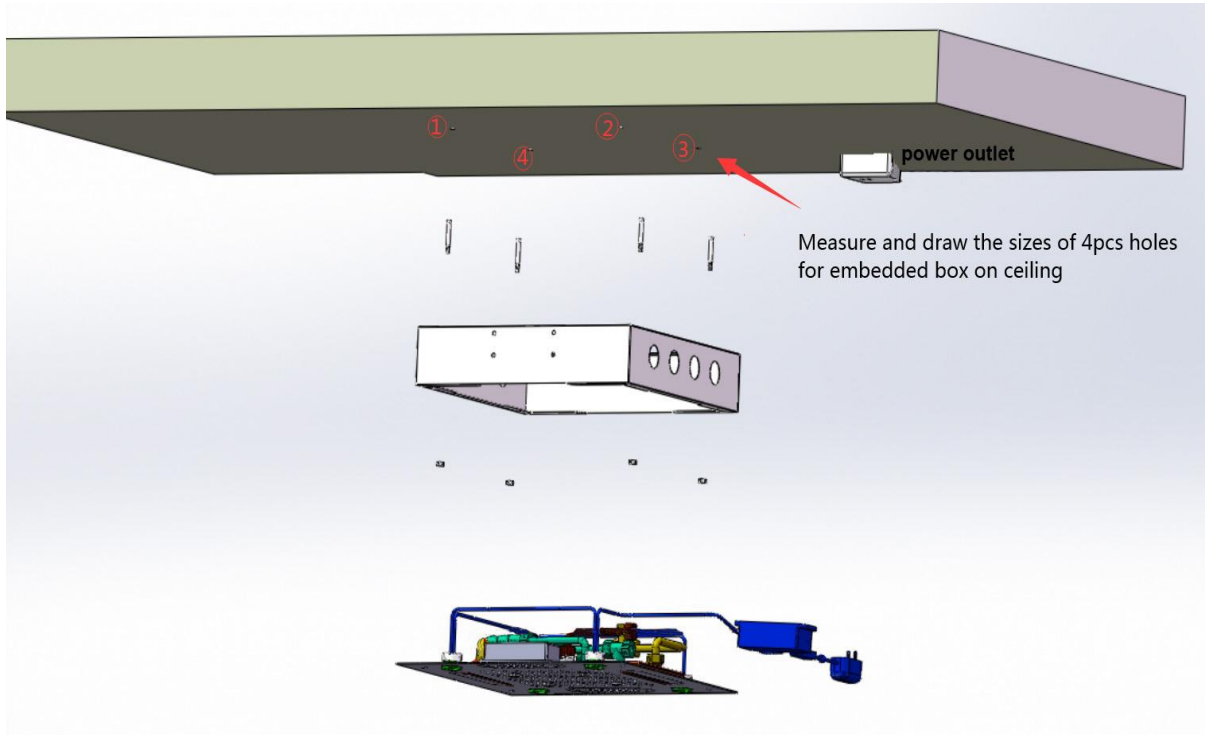

1. According to the size of shape on the mounting bracket, check the location of the installed in ceiling. Measure the holes size for the embedded box and draw the location on the ceiling.

2. After fix the embedded box on ceiling, connect the water pipes through the holes of the shower head.

3. Then assemble the main body of shower head to the embedded box, connect the water pipes to the water outlets of the shower head

Note: Please clean the water pipes and test the functions when connect water pipes.

4. Need to connect the electricity power to the shower head for led lights. Need to stick out the signal receiver.

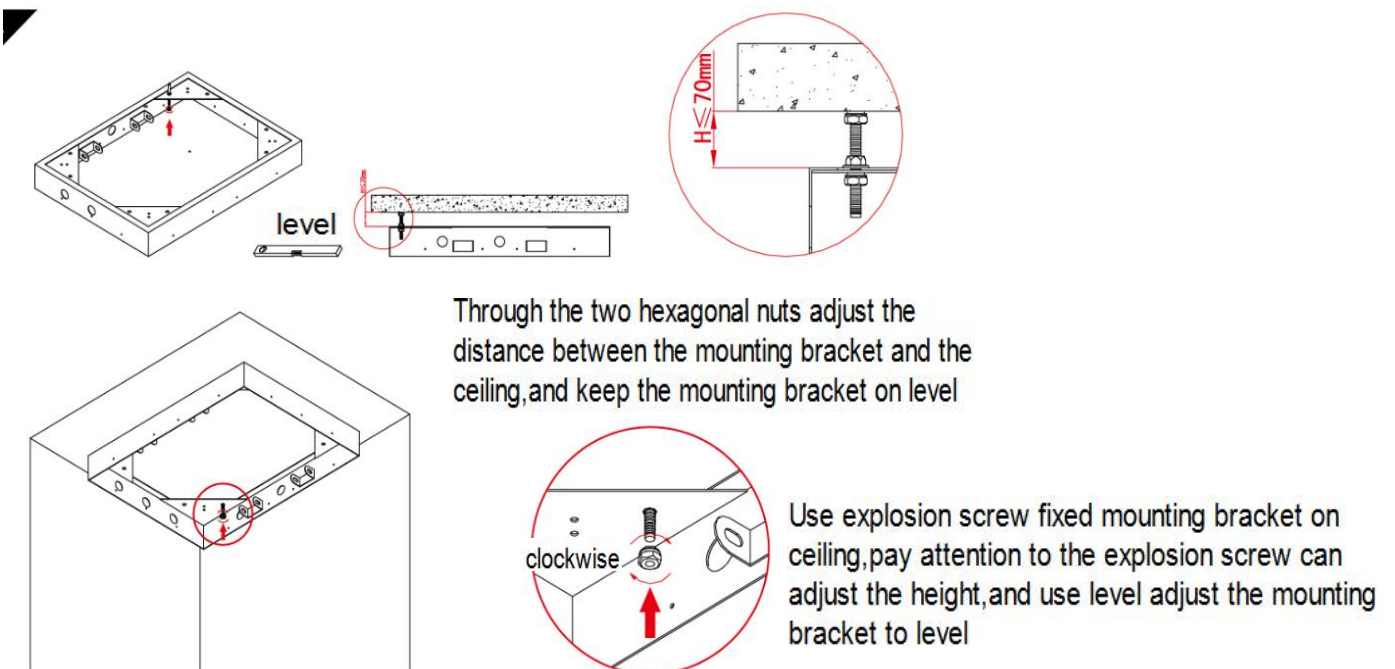

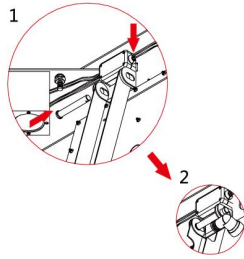
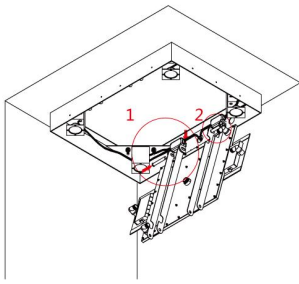

6 Lift up the shower head, aimed at the hole of bolt, according to the chart shows, plug in bolt.

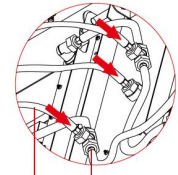
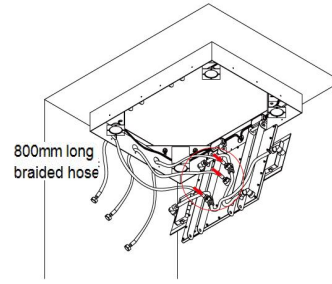

7 Connect 3pcs 800mm water hose to 2 tee joints and G1/2" joint in the middle, then put another side of the shower hose through the through hole at the side of the mounting frame.

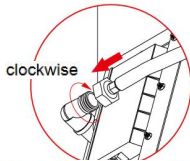
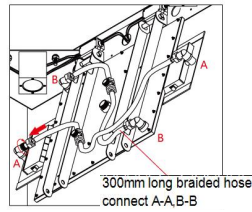
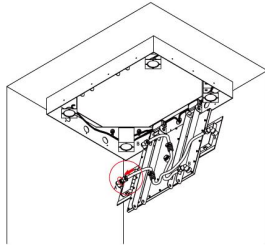

8 Connect 300mm long waterhose and tee joint, then put the water hose connect on the water inlet connector.

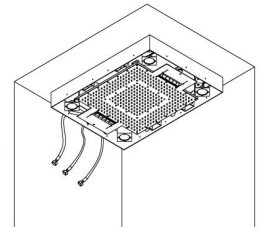
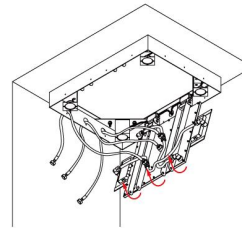

9. Cover the shower body, and loaded bolt.

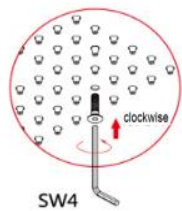
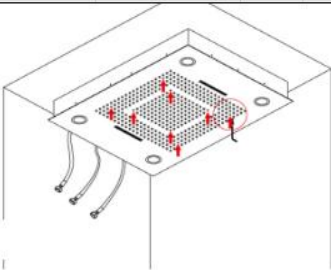

10 Install the decorative panel, use SW4 hexagen wrench tightnen 8 screws.

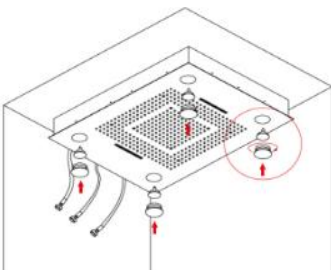
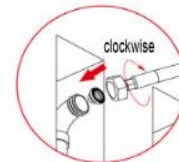
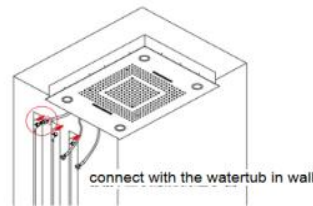

11 .Fitted four lamp cups, then screw up 4 decoration covers

12. Connect the 3 braided hoses with the embed mixed water inlet pipe Bury and seal the wall, and finally finish the shower head installation.

Note: 1. Before connect water hose and watertube, cleaning the pipes, prevent impurities from water pipes clogging flower is aspersed;
2. When connect watertube, put a G1/2" filternet in water hose, filtering impurities.

For LED light:

1. Usually user changes led lights by remote controller

Size parameters

+
...

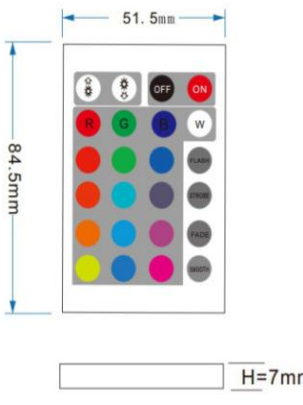

H=7mm

Name	Parameter
Operating temperature	-20-60°C
Input voltage	DC5V-24V
Output circuit	3 circuits
Output current	≤12A
Output Power	92W
Connection method	Android 4.0, Apple 4S and above
Receive distance	Indoor 8-10 meters
Support language	English, Chinese (other languages available According to mobile phone system function settings)



H=10mm

Remote control display



Infrared remote control

The key functions correspond to the following table:

RGB brightness +/ Dynamic mode speed+	RGB brightness -/ Dynamic mode speed-	Shut down	Boot
Static red	Static green	Static blue	Static white
Static rose	Static turquoise	Static sapphire	Seven colors jump
Static orange	Static cyan	Static purple gray	Seven colors flashing
Static goose yellow	Static sky blue	Static sauce purple	Seven-color gradient
Static yellow	Static cyan	Static purple	White light gradient

2. Control led light by smart phone(but only for Apple phones)

Please download "Dazzle Life" App Firstly

- ▶ Scan the following QR code to download the app.



- ▶ Sign up

a) First use can register user or directly click taste fresh experience to enter the control interface. (sign up or select 'Guest' to use)

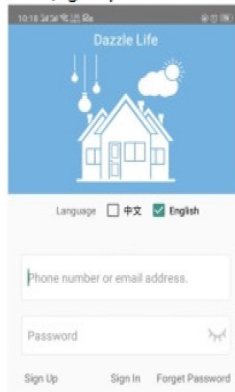

Bluetooth connection operation instruction steps:

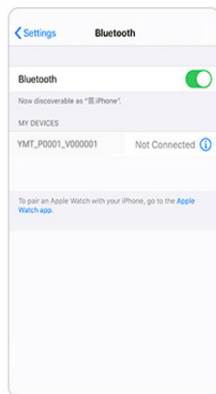

① Turn on Bluetooth

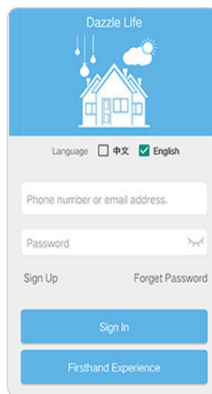

② Launch Dazzle life

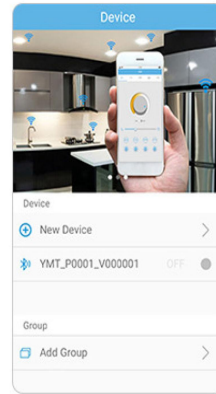

③ Adding devices and groups

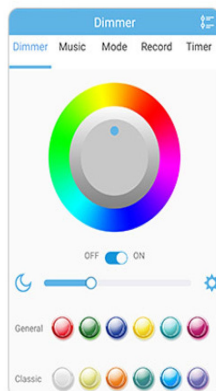

④ Change LED color and brightness



⑤ Adjust speed mode

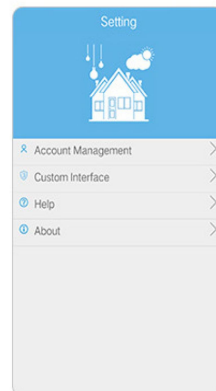

⑥ Make related settings

3. For led app:

NOTE:

1. The power supply voltage of this product is DC5V-24V, which should not be connected to other voltages.
2. The lead wires should be correctly wired according to the colors and labels provided in the wiring diagram.
3. This product cannot be overloaded.
4. If you cannot search the LED controller and cannot connect with the Bluetooth device, please turn it off in your phone settings turn on Bluetooth again, and then connect again.
5. If you cannot connect to the device for a long time or other abnormalities, please close the application and try restart.
6. Do not put the LED Bluetooth controller in a closed place with high temperature, humidity or water.
7. Non-professionals, please do not open the closed device at will.

Accessories Installation

◆ Water spout installation

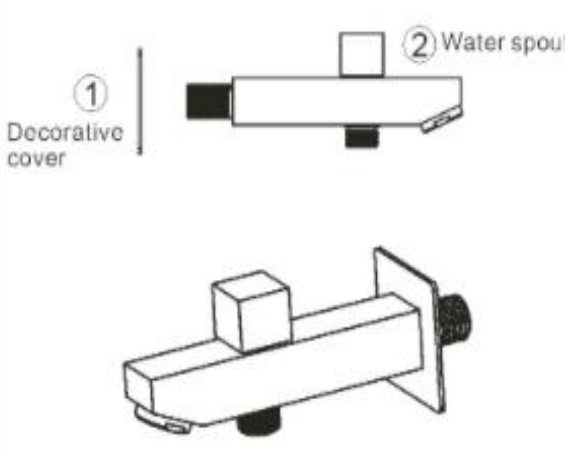

① Decorative cover

② Water spout

③ — Cup

④ — Screw

⑤ — Shunt switch

⑥ — Rubber washer

Install the decorative cover under the water spout, and then tighten it into the wall using the waterproof tape.

◆ Body jet installation

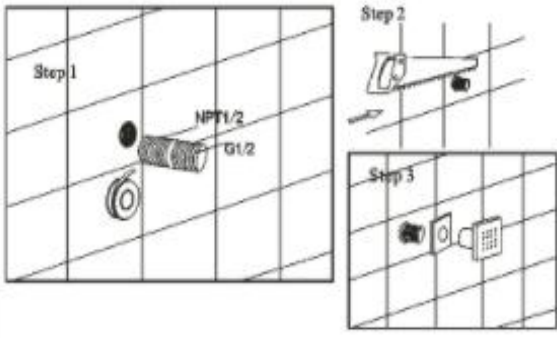

Step 1

Step 2

Step 3

NPT1/2

G1/2

Step 1 Wrap the threaded pipe of NPT1/2 with Teflon tape and screw it into the wall.

Step 2 Cut off excess part with a saw.

Step 3 Put on the decoration cap, then screw the massage shower in.

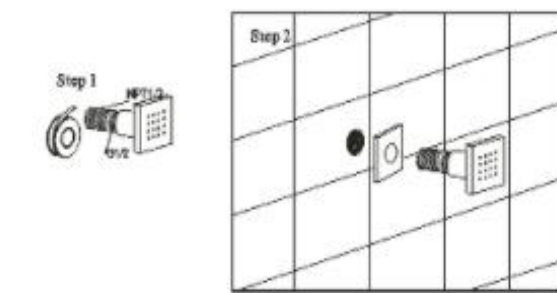

Step 1

Step 2

NPT1/2

G1/2

♦ Install the hand shower holder

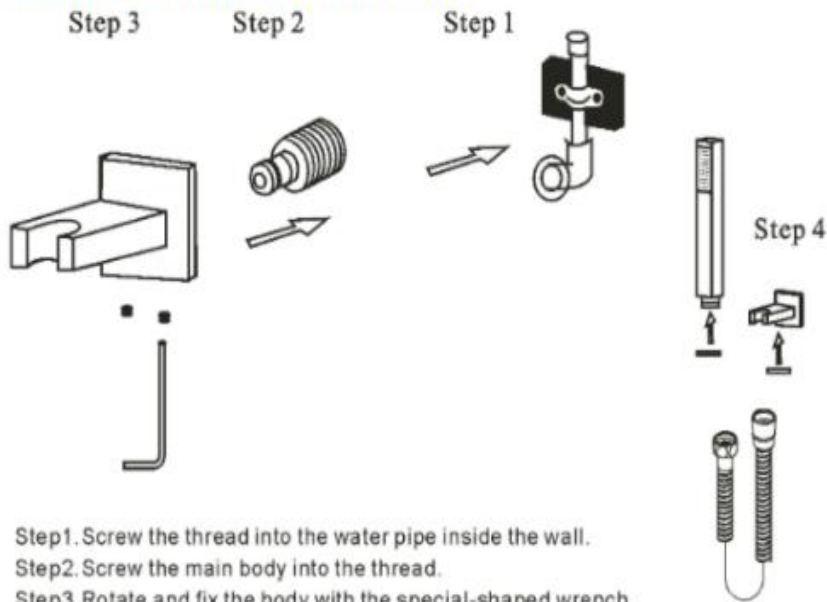

- Step1. Screw the thread into the water pipe inside the wall.
Step2. Screw the main body into the thread.
Step3. Rotate and fix the body with the special-shaped wrench.
Step4. Connect hand shower and the hose.

Care and Maintenance

In order to keep the mixer surface bright , please clean the mixer regularly.

Rinse faucet with clean water and wipe with soft cotton cloth.

Avoid using cleaning powder , harsh cleaning chemicals, brushes, and cloth with coarse surface to prevent scratching and corrosion.

Do not use acid cleaner to clean the faucet as it may cause surface corrosion of the faucet. If the faucet comes into contact with harmful acid substances, please rinse it with water immediately.



If a large-scale clean-up is necessary, follow these procedures:

1: Use clean water and soft cloth to remove dirt on the surface as much as possible.

2: Use one of the following cleaners to remove dirt on the surface

Mild liquid cleaner.

Colorless glass cleaner, powder cleaner which does not have abrasive function and can be dissolved completely.

Polish liquid which does not have abrasive function.

3: After cleaning, remove the cleansing agent with clean water completely and wipe with soft cotton cloth.